

Mechanical Dimensions : (mm)

UL Tube

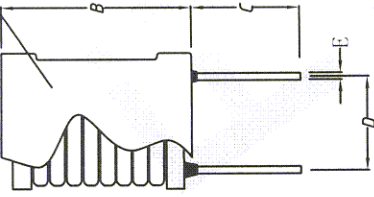

DIMENSION(mm)

- A: 8.8 MAX
- B: 12.0 MAX
- C: 8.0 MIN
- D: 5.0±0.50
- E: 0.60D/A±0.10

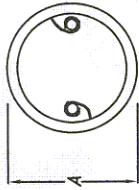

Coil structure and schematic

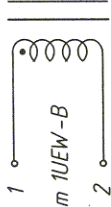

215Ts REF/0.50mm 1UEW-B

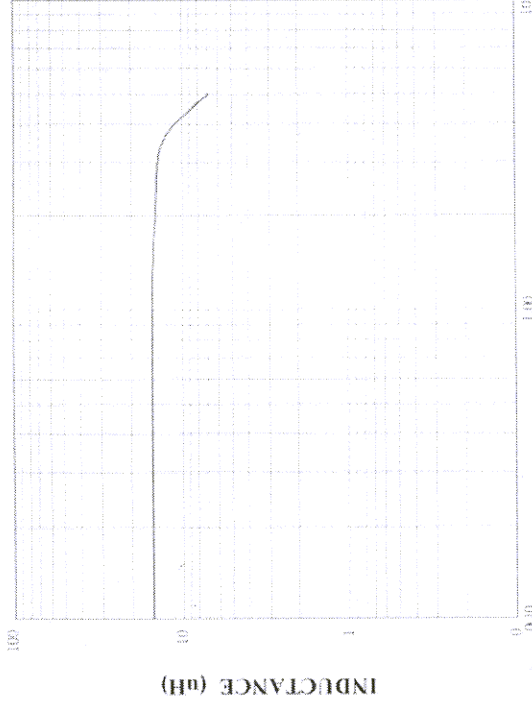

Electrical Specifications:

Inductance: at 1KHz 0.3V
 L0A=15.0uH±10%
 L2.1A>90%×L0A

D.C.Resistance: R=0.05 ohms MAX

Tube: UL Heat shrink tubing/125C.

Wire: UEW-B/130C/E158909,

core: DR2W8×10(B=4).

Operating Temperature range: -40°C to +105°C.

Note : Temp 20°C 4.8% RH. RoHS compliant.

Document is the property of FUAN Inc & is not allow to be duplicated without authorization

PROPRIETARY



05.02.12

| | | |
|--|---------------------------------------|-------------------------------|
| <p>TEL: +86-550-7814888 Fax: +86-550-7831133 www.fuantronics.com</p> | <p>Model: DR8×10 choke</p> | Customer P/N: |
| | <p>PAIRUI P/N: FALCHB0810-150K2R1</p> | DOCUMENT NO./Rev.: 1212006/00 |
| <p>Unless Otherwise Specified TOLERANCES: .X : ±0.50 .XX : ±0.25 Dimensions in mm</p> | DWN | Yuing.yu |
| | CHK | Anson zhan |
| | APP | Louis Lin |
| | | DATE: Dec./04./2012 |

Mechanical Dimensions : (mm)

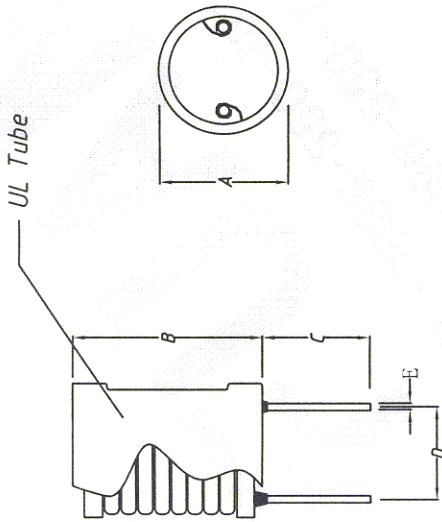

- DIMENSION:(mm)
- A: 8.8 MAX
 - B: 12.0 MAX
 - C: 8.0 MIN
 - D: 5.0±0.50
 - E: 0.60D/A±0.10

05.12.12



Electrical Specifications:

- Inductance: L_{0A}=3.3uH±20% @1KHZ 0.3V
- Rated current : 5.0A MAX.
- D.C.Resistance: R=0.013 ohms MAX
- Tube: UL Heat shrink tubing/125C.
- Wire: UEW-B/130C/E158909.
- core: DR2W8x10(B=4).
- Operating Temperature range: -40°C to +105°C.

Note : Temp 20°C 48%RH. RoHS compliant.

PROPRIETARY Document is the property of FUAN Inc & is not allow to be duplicated without authorization

Coil structure and schematic

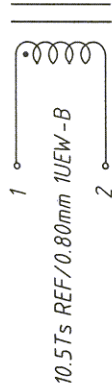

10.5Ts REF/0.80mm 1UEW-B

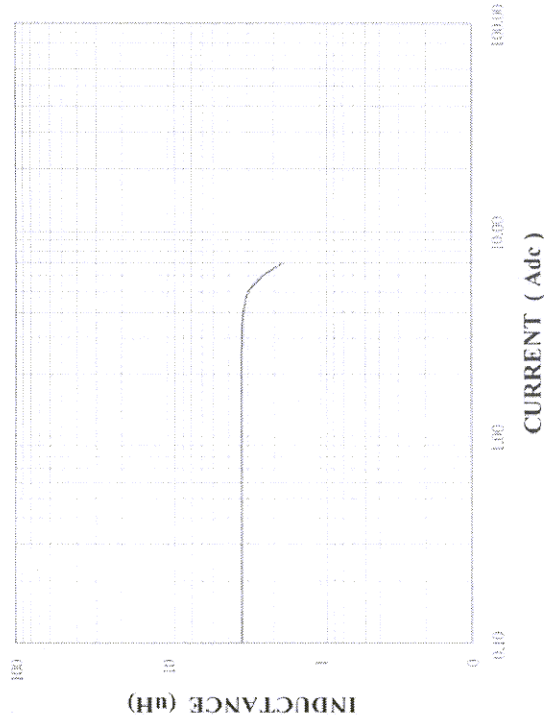

| | | | |
|---|-------------|--------------------|----------------------------------|
| TEL: +86-550-7814888 Fax: +86-550-7831133 www.fuantronics.com | Model: | DR8x10 choke | Customer P/N: |
| | PAIRUI P/N: | FALCHB0810-3R3M5R0 | DOCUMENT NO./Rev.: 1211044/00 |
| Unless Otherwise Specified TOLERANCES: .X : ±0.50 .XX : ±0.25 Dimensions in mm | DWN | Yuing.yu | DATE: Nov./30/2012 |
| | CHK | Anson zhan | |
| | APP | Louis Lin | |